

TruLaser

Cost-effective
cutting through
thick and thin



The best solution for your application

The right laser for your cutting application, the right machine for your production, the automation that matches your material flow – this is what TRUMPF delivers. Our large range of laser cutting machines assures that you receive the right product. The vital questions for choosing the right machine are about your situation: What are your requirements regarding material and quality? How high is your average capacity? What do you need to make your manufacturing as cost-effective as possible?

Laser cutting is not only about cutting times. The entire process is important. Intelligent functions, for instance, help to design single processing steps in a smarter way. A large service network supports you if necessary. With TRUMPF, you receive suitable solutions: perfectly balanced, highly productive and passionately crafted.



Select the right application for your tasks.

Produce variety **4 – 5**

Design your processes efficiently and use the full potential of your machine.

More output with intelligent functions **6 – 7**

Get to know the TruLaser machines.

Our machines in detail **8 – 21**

In this section you can find an overview of the technical details of all TruLaser machines.

Technical data **22 – 25**

Select the right automation solution or switch directly over to the fully automatic laser machine.

Automation and TruLaser Center 7030 **26 – 31**

Find out more about our CO₂ laser machine.

Cutting edges as smooth as glass with the CO₂ laser **32 – 37**

Our solutions will support you step-by-step on the way to your Smart Factory.

Take control **38 – 39**

With TruServices, you enjoy the benefits of a quotation that goes far beyond the machine itself.

Everything from a single source **40 – 43**

Produce variety

From smooth cutting edges on mild steel as thick as a finger to tubes: Thanks to intelligent functions, your 2D laser cutting machine masters an almost infinite variety of contours and materials. And it also proves to be ideal when faced with challenging geometries. Do you make full use of your machine's laser power?



01 TruDisk 24001



02 Nanojoint

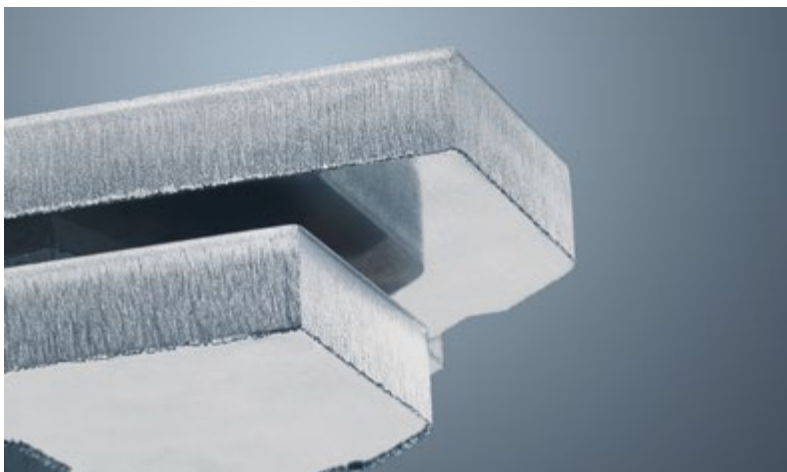

03 Gas mix



04 FlexLine



05 RotoLas



06 CoolLine

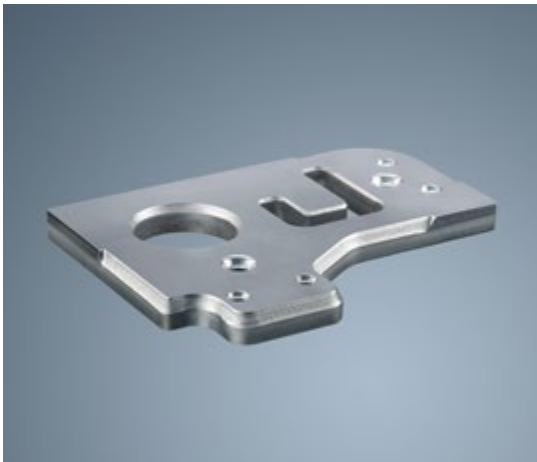

07 EdgeLine



08 Copper/brass

01 TruDisk 24001, machine: TruLaser Series 5000
Laser power: TruDisk 24001
Optional: Yes
Material: Mild steel, stainless steel, aluminum, copper, brass, titanium
Sheet thickness: Mild steel/stainless steel/aluminum 1–60 mm, copper 1–15 mm, brass 1–12 mm, titanium 1–6 mm
Special features: Significantly improved productivity and part quality in fusion cutting for mild steel and stainless steel with medium to very thick sheets

02 Nanojoint, machine: TruLaser Series 1000, 3000, 5000
Laser power: From TruDisk 4001/TruFiber 4001
Standard scope of delivery
Material: Mild steel, stainless steel
Sheet thickness: Mild steel 1–20 mm, stainless steel 1–12.7 mm
Special features: Greater process reliability during cutting and automated unloading of sheets or components. Scrap reduction by up to 30%

03 Gas mix, machine: TruLaser Series 1000, 3000, 5000
Laser power: TruDisk 12001, TruDisk 24001
Optional: Yes
Material: Mild steel, aluminum
Sheet thickness: Mild steel 6–20 mm, aluminum 3–15 mm
Special features: Improved part quality is possible due to decreased burr formation with medium to thicker mild steel and aluminum

04 FlexLine, machine: TruLaser Series 3000, 5000
Laser power: TruDisk 12001, TruDisk 24001
Optional: Yes
Material: Mild steel
Sheet thickness: 12–30 mm
Special features: High part quality in various grades of material and surface finishes

05 RotoLas, machine: TruLaser Series 3000
Laser power: TruDisk 4001 to TruDisk 12001
Optional: Yes
Material: Mild steel, stainless steel, aluminum, copper, brass
Sheet thickness: Mild steel 1–10 mm, stainless steel 1–5 mm, aluminum 1–5 mm, copper 1–4 mm, brass 1–4 mm
Special features: The RotoLas tube cutting unit enables the processing of tubes and profiles on the 2D laser machine

06 CoolLine, machine: TruLaser Series 1000, 3000, 5000
Laser power: From TruDisk 4001
Optional: Yes
Material: Mild steel
Sheet thickness: 15–25 mm
Special features: For CoolLine, the cutting process is cooled by spraying a directed water mist around the processing point. This enables delicate and material-efficient mild steel cutting.

07 EdgeLine, machine: TruLaser Series 1000, 3000, 5000
Laser power: From TruDisk 4001
Optional: Yes
Material: Mild steel (chamfers, countersinks, radii), stainless steel (radii)
Sheet thickness: Mild steel 2–25 mm, stainless steel 1–8 mm
Special features: Produce chamfers, counterbores and radii on the laser cutting machine, even during the cutting process

08 Copper/brass, machine: TruLaser Series 1000, 3000, 5000
Laser power: From TruDisk/TruFiber 3001
Standard scope of delivery
Material: Brass, copper
Sheet thickness: Copper 1–16 mm, brass 1–12.7 mm
Special features: Non-ferrous metals can be cut without restrictions

More output with intelligent functions

Preparing

How is my machine doing?

The light on the **Condition Guide** shows you at a glance the status of important elements that affect the cutting ability of the machine; if necessary, the program provides you with recommended courses of action and generates predictions of when maintenance will be required.



Are my nozzles working properly?

If not, this can lead to burr formation, resulting in parts requiring reworking or reject parts.

Smart Nozzle Automation switches to the correct nozzle and checks the nozzle status and beam centering. This helps ensure reliability and saves you time.

Is my sheet metal positioned correctly?

This is important in particular if you wish to cut prepunched sheet metal. With **DetectLine**, a camera system precisely determines the position of inserted sheets. This function also helps to check the alignment of the focus position.

Is my lens or protective glass contaminated?

Spatter can contaminate the focusing lens of CO₂ machines. **LensLine** monitors your lens and switches off the beam if necessary. The benefit to you: Short downtimes for lens cleaning need only be scheduled when required, and you only need to replace protective glass if it is truly necessary. The **online protective glass status check** ensures that you always know the condition of the protective glass of your solid-state laser and can work with consistent quality.

How do I tackle cutting problems?

The **Cutting Guide** supports you with finding the cause for cutting problems. It offers functions for inspection in order to adjust the machine optimally.

Producing

Can I cut inferior material?

Active Speed Control monitors the cutting process in real time. In the event of sheet thickness variations or quality fluctuations such as rust or coating remnants, the system adjusts the correct feed rate on its own. Alternatively, **AdjustLine** chooses robust cutting data before the cutting process starts.

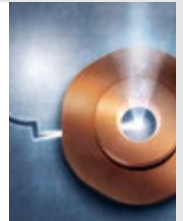

EdgeLine Bevel

The EdgeLine Bevel feature can now do even more: Cut chamfers, counterbores and round edges directly on your laser cutting machine. Rounded edges look better and prevent injuries. Easy programming also allows you to machine chamfers with different angles and counterbores in multiple sizes.

How can I protect my cutting head?

There is a particular danger of collision due to parts tipping over when cutting thin sheet metal. The **collision protection function** minimizes the effects of this – acting as a kind of airbag for your cutting head.

Can I cut quicker and save money at the same time?

The **Highspeed Eco** cutting turbo enables you to double your plate throughput and your feed rate, while reducing your cutting gas consumption by up to 70%. This makes nitrogen cutting with solid-state lasers extremely efficient.



What good is having the quickest machine if your parts keep tipping over? With 2D laser cutting machines, downtimes can quickly take up half of your working time. These downtimes are spent setting up your machine, sorting or rectifying faults. This is why it makes sense to shorten your entire process and permanently ensure that power is converted into output – with intelligent functions from TRUMPF.

Sorting

How can I prevent collisions?

With **Smart Collision Prevention**: Your machine manufactures parts and inside contours in a sequence that intelligently takes parts tipping over into account. This means you can carry out production reliably – without collisions or microjoints.



This function is also available as a test or rental version.



Neat cuts – quick removal

With **BrightLine**, your CO₂ laser can achieve the ultimate in edge quality when cutting stainless steel and structural steel. However, thanks to **BrightLine fiber**, solid-state lasers can also provide exceptionally high-quality cutting results across the entire range of sheet thicknesses and with no reduction in cutting speed. In addition, optimized, high-quality cutting gaps save time in sorting and further processing.

Where does each part belong?

The **Sorting Guide** marks parts by color on a monitor depending on the order, downstream processes or geometry. This prevents mistakes.

Starting the subsequent process

How can I identify my parts?

Consider the next process step while still carrying out cutting: the **Dot Matrix Code** ensures that you always know which part you are working on and what processes need to be carried out on it.



This function is also available as a test or rental version.

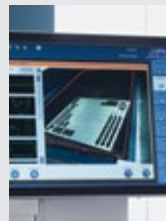

I need to reproduce a part quickly

Speed and reuse of leftover sheet metal are crucial factors here. Thanks to the camera support offered by **Drop&Cut**, you can produce parts from existing programs in seconds. This system also enables you to reuse leftover sheet metal.

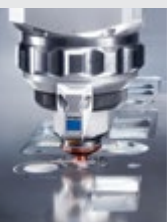

Can I also cut thick structural steel?

Yes – with **CoolLine**, even tight contours are possible. This function keeps your workpiece consistently cool during cutting. This enables you to cut even delicate parts and to nest workpieces even more tightly.

Changing cutting heads takes up too much time!

Simply get rid of the process entirely: with the **one-cutting-head** strategy you can machine any sheet thicknesses with a single cutting head.

The basics of machine selection



Successful cutting: TruLaser Series 1000

Combines first-class TRUMPF quality with low investment and operating costs.



Flexible standard machine: TruLaser Series 3000

With this fast all-rounder, you can cut all sheet thicknesses flexibly and economically.



Productive machine with solid-state laser: TruLaser Series 5000

The dynamic powerhouses deliver high part quality that can be reproduced, even with complex contours.

No two productions are the same. That's why your applications determine which laser machine is right for you. We make it easier for you to choose thanks to a clearly defined portfolio. And with comprehensive packages where everything fits together harmoniously: machine, laser, automation, software and a service that you can always count on – anytime, anywhere.



Productivity

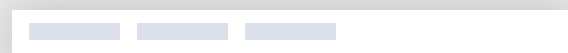

Flexibility

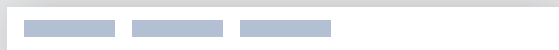

Autonomy

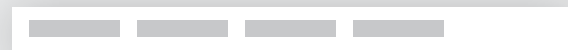

Processing formats

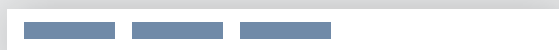

Ergonomics

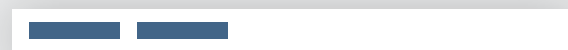

Investment



Productivity

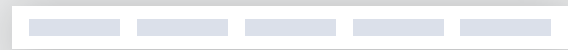

Flexibility

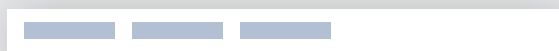

Autonomy



Processing formats

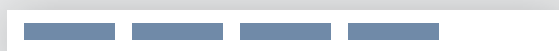

Ergonomics



Investment

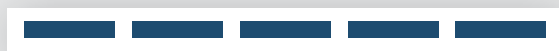

Productivity

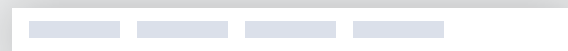

Flexibility

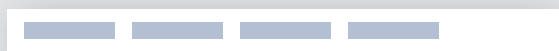

Autonomy

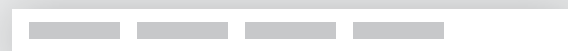

Processing formats

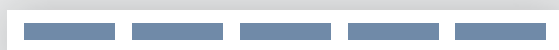

Ergonomics



Investment

TruLaser Series 1000

01

Cost-effective and productive

with Highspeed Eco and Drop&Cut

02

Robust and reliable

thanks to CoolLine and collision protection

A cut above the rest: You can perform laser cutting at the push of a button with the TruLaser Series 1000. It provides many technological functions and is already worthwhile, even at low utilization levels thanks to the low investment and operating costs combined with maximum throughput and TRUMPF's high quality standard.

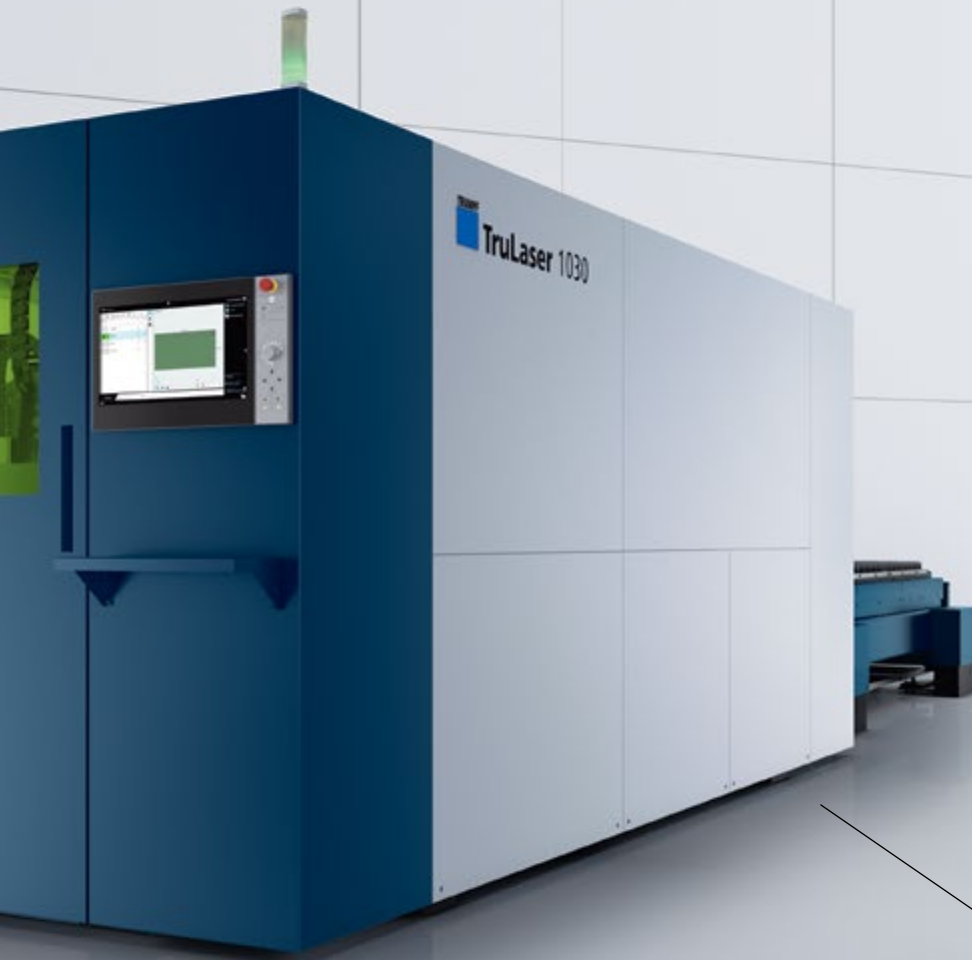

03

Top parts quality

with BrightLine fiber

04

Easy to operate and network

due to the touch display
and Central Link

01

Cost-effective and productive

with Highspeed Eco and Drop&Cut

You will set speed records with the Highspeed Eco cutting process: Depending on the sheet thickness, the feed rate increases by up to 70%. In addition, you achieve cutting gas savings of around 70%. Drop&Cut helps you make optimal use of remainder sheets. This saves material and time. A camera projects the image of the machine interior onto your user interface, and you can arrange part geometries on the remainder sheet as needed.

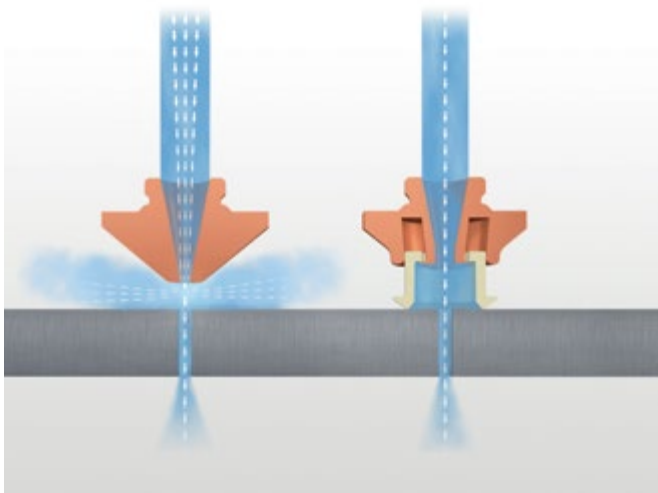

Highspeed Eco – clever nozzle: Highspeed Eco reduces your cutting gas consumption by up to 70%.



Drop&Cut: With Drop&Cut, you can produce single parts in seconds.

02

Robust and reliable

thanks to CoolLine and collision protection

With CoolLine your workpiece remains cool – that opens up possibilities for geometries, facilitates closer placement of components, and also ensures reliable cutting of thick mild steel. The collision protection protects your cutting head like an airbag, giving you the ability to manufacture particularly reliably and productively thanks to minimal non-productive time.

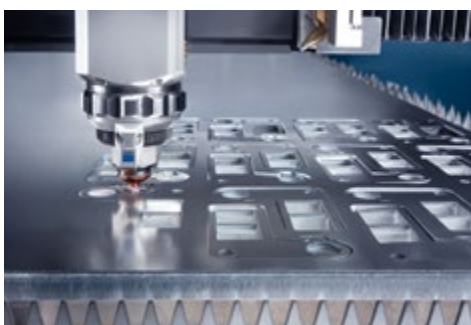

With CoolLine, you can even cut tight contours in thick mild steel and thus also increase your process reliability.

03

Top parts quality

with BrightLine fiber

With flexible adjustment of the laser beam and special cutting data, BrightLine fiber converts your solid-state laser into an universal tool. The function enables high-quality cutting results in any sheet thickness. At the same time, you have access to all advantages of thin sheet processing with the solid-state laser, primarily the high speeds.



Smoothest possible cutting edges across the entire sheet thickness range are no problem thanks to BrightLine fiber.

Smart Collision Prevention 5.0

“No need to worry about collisions. In addition, Smart Collision Prevention reduces the processing time in the new single-part mode by more than a third – for sheets of up to 10 mm. Nanojoints also save you the need for reworking.”

Marcel Maier, product manager TruLaser

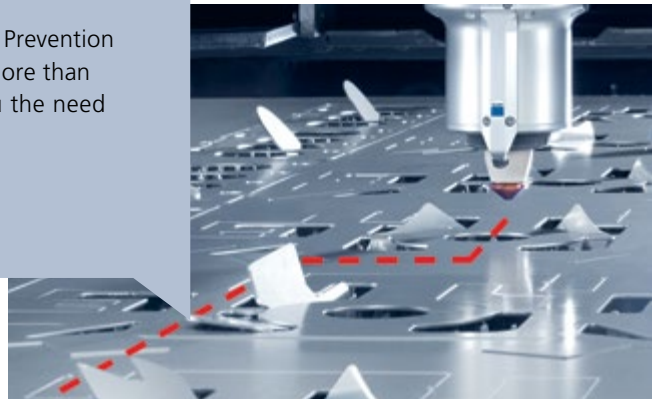

04

Easy to operate and network

due to the touch display and Central Link

The menu navigation on the large touch display works intuitively. Due to the reliable, integrated cutting parameters from TRUMPF, the machine is very easy to operate. With Central Link and automation options, you can create a digital and physical network.



Generously dimensioned and easy to operate – the touch display of the TruLaser Series 1000.



Everything at a glance with the mobile display of the control panel.



An introduction to automated manufacturing. Microstorage with automatic loading and unloading of the laser cutting machine at low investment costs.

TruLaser Series 3000

01

Limitless flexibility

in terms of format, power and options

02

High-quality results

in all sheet thicknesses

03

Go full throttle

while saving cutting gas

The machines of the TruLaser Series 3000 are true all-rounders in laser cutting, and are extremely flexible and reliable.



04

Versatile automation

for an uninterrupted process chain

05

Improve part quality

with the integrated gas mixer

01

Limitless flexibility

in terms of format, power and options

You can completely customize the layout of your machine to suit your needs: You can choose between large format (3 × 1.5 m), max-format (4 × 2 m) or even oversize format (6 × 2.5 m, 8 × 2.5 m). You also have options when it comes to laser power: 4, 6, 8, 10, 12 or 24 kW.

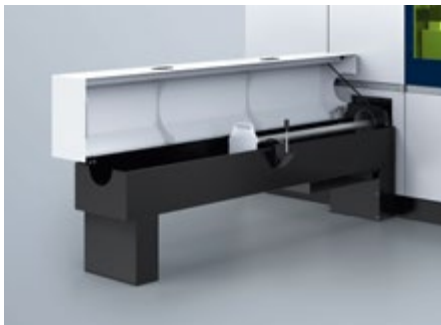

RotoLas enables you to add pipes and profiles to the range of parts you can produce.

03

Go full throttle

while saving cutting gas

Using the Highspeed method, you can carry out nitrogen cutting with the solid-state laser in record time: This method enables you to nearly double your feed rate and sheet throughput when processing medium and thick structural steel and stainless steel sheets. The new nozzle design reduces your cutting gas consumption by up to 40% and even prevents burr formation on contours with sharp edges. And if that's not enough, with Highspeed Eco you reduce cutting gas consumption by up to 70%.

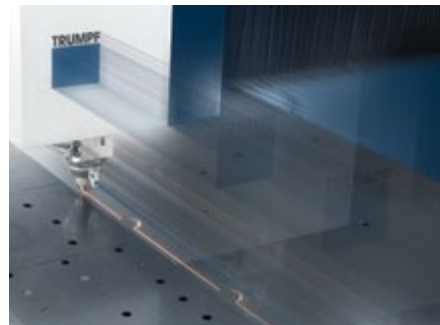

Go full throttle and save gas: With Highspeed, your cutting gas requirements are reduced by up to 40%, while your sheet throughput is increased by up to 100%.

02

High-quality results

in all sheet thicknesses

BrightLine fiber turns your solid-state laser into a universal tool: This function provides high-quality cutting results in all sheet thicknesses, while still enabling you to enjoy all of the benefits of thin sheet processing with a solid-state laser, most notably high cutting speeds.

Zoom cutting unit: Thanks to the large zoom range, the focus position and focal diameter of this cutting unit are completely variable: they automatically adapt to any material.



With BrightLine fiber, you can cut a wide variety of materials and sheet thicknesses with the best possible quality.



You can achieve the best results in all sheet thicknesses with the zoom cutting unit.



Nanojoints

“Little helpers with a big impact: Nanojoints make it possible to process any component geometry safely and productively. Minimal fixing in the scrap skeleton saves reworking.”

Patrick Mach, Development, Laser Cutting

04

Versatile automation

for an uninterrupted process chain

With the right automation solution, you can optimize your process chain for specific requirements: Select the required components from a large modular system. From simple loading through to fully automated loading and unloading including part separation and storage connection, everything is now possible with the TruLaser Series 3000.



A strong team: LiftMaster Compact automatically loads and unloads your machine. With the PartMaster, you can manually remove finished parts and grid residue from the transport belt with ease while production is in progress. More information on the topic of automation is available on pages 26 and 27.

05

Improve part quality

with the integrated gas mixer

The integrated gas mixer mixes the cutting gases together. The mixing ratio can be calibrated automatically without any operator involvement via the user interface. This reduces rework and improves your part quality.



Increase the quality of your parts and reduce rework to a minimum with the integrated gas mixer.

TruLaser Series 5000



01

Maximum dynamics

even with complex contours

02

Producing with process reliability

even in fully automated operation

03

High material tolerance

with FlexLine

The high-power products in the TruLaser Series 5000 set new standards for productivity and cost-effectiveness.



05

Semi-autonomous laser cutting
with Active Speed Control

04

Improve availability
thanks to Smart Rerun

01

Maximum dynamics

even with complex contours

The productive machines in the TruLaser Series 5000 can effortlessly handle both thin and thick sheets. With the TruDisk 24001 and highly dynamic drives, they enable highly productive and reliable manufacturing across the entire range of sheet thicknesses. The machines in this range are designed for maximum capacity and are able to convert these high feed rates into sheet throughput.



With the 24 kW TruDisk 24001 laser, you can process a wide range of materials in the best possible quality with even higher productivity.

02

Producing with process reliability

even in fully automated operation

Ensuring that the nozzle and lens are in the best possible condition is an important prerequisite for achieving reliable processes and high part quality. Smart Nozzle Automation combines intelligent functions that ensure just that – even in fully automatic operation. With the CoolLine function, you can perform delicate cutting operations, even in thick structural steel. This function cools the workpiece during cutting and enables new geometries, more efficient sheet configuration, and reliable processing of thick structural steel.



Smart Nozzle Automation ensures that the nozzle and lens are kept in the best possible condition.



The LiftMaster Compact loads and unloads the TruLaser 5030 fiber particularly quickly. You can find out more about automation on pages 26 and 27.

TruDisk 24001

“With an impressive 24 kW, the new TruDisk doubles the laser power of the TruLaser Series 5000. This allows you to process components up to three times faster and increase sheet throughput by up to 80% per hour.”

Andreas Vollmer, TruLaser technology expert from the demonstration center



03

High material tolerance

with FlexLine

With the FlexLine function, you can cut mild steel of various grades reliably and to a high standard of quality. The combination of specific cutting parameters and a patented nozzle design ensures a particularly high material tolerance. This gives you more flexibility in your production and enables you to save material costs, especially with high sheet thicknesses. In addition, even delicate contours can be safely cut. This allows you to get the most out of your material.



FlexLine: Cut fluctuating material grades robustly, safely and to a high standard.

04

Increase availability

thanks to Smart Rerun

More autonomy, fewer downtimes: With Smart Rerun, your machine carries on producing independently after a slight collision or cutting flaw. It reenters the contour to prevent rejects. It only jumps to the next part if it cannot reenter the contour.



With Smart Rerun, production continues independently after minor collisions or cutting flaws.

05

Semi-autonomous laser cutting

with Active Speed Control

Another milestone on the way to the autonomous machine: Active Speed Control. The system sees through the nozzle into the kerf, monitors the cutting process, and regulates the feed rate on its own. Even in the event of thickness variations in a sheet, or if the sheet has been affected by quality fluctuations such as rust or coating remnants, the system ensures the right feed rate for flame and fusion cutting. Cutting disruptions are prevented which reduces the amount of reject parts significantly.

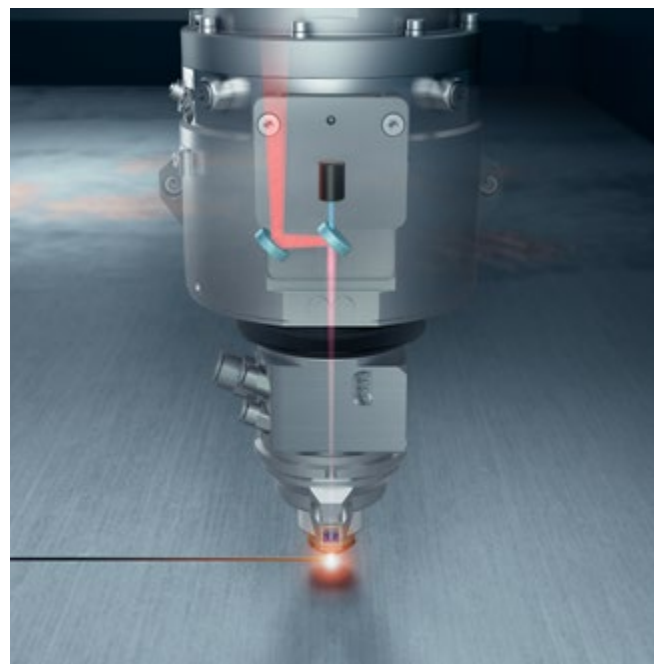

Active Speed Control, the adaptive feed rate regulation, increases process reliability and relieves operators.

Technical data

We have summarized the technical data for the TruLaser machines for you on these pages.

Technical data					
		TruLaser 1030 fiber	TruLaser 1040 fiber	TruLaser 1060 fiber	TruLaser 3030 fiber
Maximum format size that can be processed					
X-axis	mm	3000	4000	6000	3000
Y-axis	mm	1500	2000	2500	1500
Z-axis	mm	116	116	116	116
Workpiece					
Max. weight (up to 6 kW)	kg	900	2000	2900	1100
Max. weight (8 kW and higher) ^[1]	kg	1800	3300	4900	1800
Max. speed					
Simultaneous ^[2]	m/min	140	140	140	170
Accuracy^[1]					
Positioning deviation P _a	mm	0.07	0.07	0.07	0.05
Average positioning scatter band P _{s max}	mm	0.03	0.03	0.03	0.03
Available lasers		TruDisk 4001/6001/ 8001/10001/ 12001 TruFiber 3001/4001	TruDisk 4001/6001/ 8001/10001/ 12001 TruFiber 3001/4001	TruDisk 4001/6001/ 8001/10001/ 12001 TruFiber 3001/4001	TruDisk 4001/6001/ 8001/10001/ 12001/24001

Laser data								
		TruLaser Series 1000 fiber						
		TruDisk 4001	TruDisk 6001	TruDisk 4001	TruDisk 6001	TruDisk 8001	TruDisk 10001	TruDisk 12001
Max. power	W	4000	6000	4000	6000	8000	10000	12000
Wavelength	µm	1.03	1.03	1.03	1.03	1.03	1.03	1.03
Max. sheet thickness								
Structural steel	mm	20/25 ^[4]	25/32 ^[4]	20/25 ^[4]	25/32 ^[4]	25/32 ^[4]	25/32 ^[4]	30/35 ^[4]
Stainless steel	mm	20/35 ^[4]	25/35 ^[4]	20/35 ^[4]	25/35 ^[4]	30/35 ^[4]	40	40/50 ^[4]
Aluminum	mm	20	25	20	25	25	30	30
Copper	mm	8	10	8	10	12.7	12.7	12.7
Brass	mm	8	10	8	10	10	12.7	12.7
Power consumption								
Average power consumption during production	kW	13	15	13	15	17	19	25

^[1]Data relates to a single pallet. When loading several pallets, different values apply. ^[2]The positioning accuracy data relates to the entire working length. The positioning accuracy is recorded in a production plant in accordance with VDI/DGQ 3441. ^[3]With fully adaptive cutting unit. ^[4]With cutting package for thick sheets. ^[5]With fully adaptive cutting unit and cutting package for thick sheets. ^[6]With BrightLine fiber.

TruLaser 3040 fiber	TruLaser 3060 fiber	TruLaser 3080 fiber	TruLaser 5030 fiber	TruLaser 5040 fiber	TruLaser 5060 fiber
4000	6000	8000	3000	4000	6000
2000	2500	2500	1500	2000	2000
116	116	116	116	116	116
2000	2900	4710	1100	2000	2900
3300	4900	7850	1800	3300	4900
170	170	170	283	283	283
0.05	0.05	0.05	0.05	0.05	0.05
0.03	0.03	0.03	0.03	0.03	0.03
TruDisk 4001/6001/8001/ 10001/12001/24001	TruDisk 4001/6001/8001/ 10001/12001/24001	TruDisk 4001/6001/8001/ 10001/12001/24001	TruDisk 6001/8001/10001/ 12001/24001	TruDisk 6001/8001/10001/ 12001/24001	TruDisk 6001/8001/10001/ 12001/24001

TruLaser Series 3000 fiber	TruLaser Series 3000/5000 fiber				
TruDisk 4001	TruDisk 6001	TruDisk 8001	TruDisk 10001	TruDisk 12001	TruDisk 24001
4000	6000	8000	10000	12000	24000
1.03	1.03	1.03	1.03	1.03	1.03
20/25 ^[4]	25/32 ^[4]	25/30 ^[3] /32 ^[4]	30/32 ^[4]	30/35 ^[4] /50 ^{[4][5]}	40/60 ^[4]
20/35 ^[4]	25/35 ^[4]	30/35 ^[4] /40 ^[3]	40	40/50 ^{[4][5]}	40/60 ^[4]
20	25	25	30	30/40 ^{[4][5]}	40
8	10	12.7/16 ^[3]	12.7/16 ^[3]	12.7/16 ^[3]	16
8	10	10	12.7	12.7	12.7
13	15	17	19	25	33

Subject to alteration. Only specifications in our offer and order confirmation are binding.

Intelligent functions

Which intelligent functions are available to you with which machine series?

This table provides you with a simple overview.



TruLaser Series 1000

Solid-state



TruLaser Series 3000

Solid-state

Laser type	TruLaser Series 1000	TruLaser Series 3000
Active Speed Control		
AdjustLine	■	■
BrightLine fiber	■	■
Cutting Guide	■	■
Condition Guide	■	■
CoolLine	■	■
DetectLine	■	■
Dot Matrix Code	■	■
Drop&Cut	■	■
Dynamic Focus Control	■	■
EdgeLine Bevel	■	■
FlexLine		■
One-cutting-head strategy	■	■
Hightspeed	■	■
Hightspeed Eco	■	■
Integrated gas mixer	■	■
Collision protection	■	■
Online condition checking, protective glass	■	■
PierceLine	■	■
Smart Collision Prevention	■	■
Smart Nozzle Automation		
Smart Rerun		■

Automation is worth it

Automated, your TruLaser cutting machine works even more productively. Select from a large assembly kit of modular automation components. This provides you with a solution tailored precisely to your needs, ranging from semiautomatic loading through to a fully automated machine with a storage connection.



Automation functions

Loading

Loading and unloading

LoadMaster

LiftMaster Compact

LiftMaster Linear Basic



Combinable machines

TruLaser Series 1000

TruLaser Series 3000

TruLaser Series 5000



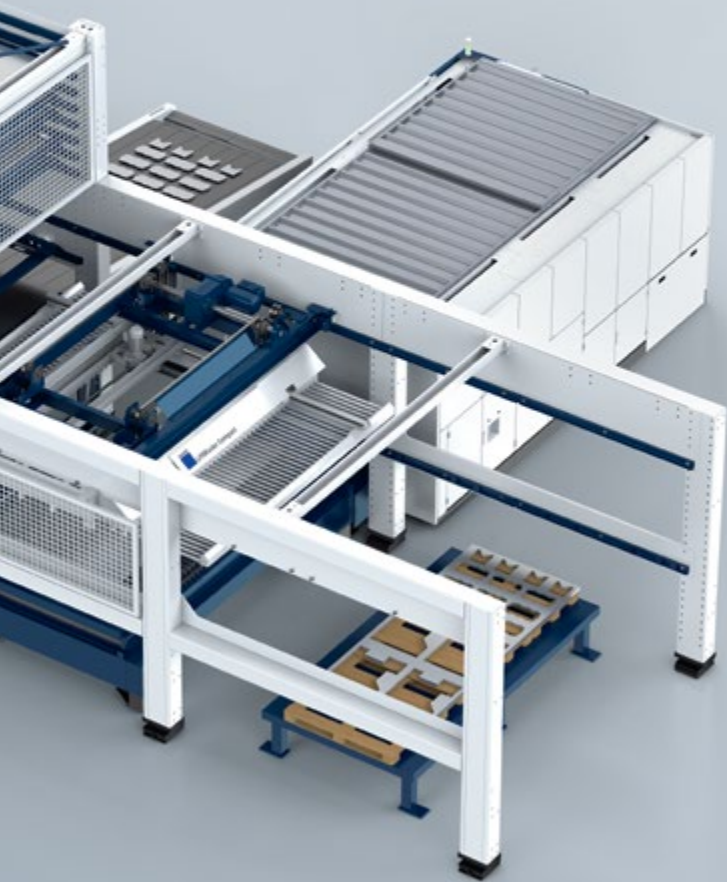







Regardless of the extent to which you wish to automate your processes: you can find the right solution for your production processes on our website and in the automation catalog: www.trumpf.info/zqi2wh

Loading and unloading/part sorting

Storage system

Loading and unloading/part sorting			Storage system		
LiftMaster	LiftMaster Linear	LiftMaster Store LiftMaster Store Linear	SortMaster	Material buffer	TruStore
					
■	■	■	■	■	■
■	■	■	■	■	■
■	■	■	■	■	■

TruLaser Center 7030

The first full-service laser machine. Takes care of everything – from drawings to sorted parts.



All laser cutting processes come together in the TruLaser Center which greatly reduces your throughput time and part costs. Reworking is no longer needed and you have excellent quality straightaway, without microjoints, without risk of collisions. One major added benefit is the automatic sorting function: Idle state due to manual sorting is now a thing of the past. The machine produces finished parts – so you can increase your number of orders without additional personnel.

Get a dynamic start

With the TruLaser Center 7030, the cutting head and sheet metal move. Thanks to an additional axis at the cutting head and overlapping axis motion, it is extremely powerful and cuts very dynamically with up to 12 kW of perfectly utilized laser power.

Reliable automation

The machine ensures reliable parts handling thanks to integrated automation. Tipping and tilting of workpieces and using microjoints are now things of the past.

Production around the clock

When connected to a storage system, the fully automatic machine supplies itself with material and stores finished parts, which maximizes utilization. Around the clock, the machine relieves you of tiresome and monotonous work steps and thus relieves the strain on employees.

Fast Reliable Independent



Short film:
Simply explained
www.trumpf.info/gabuym



A comparison of the process steps

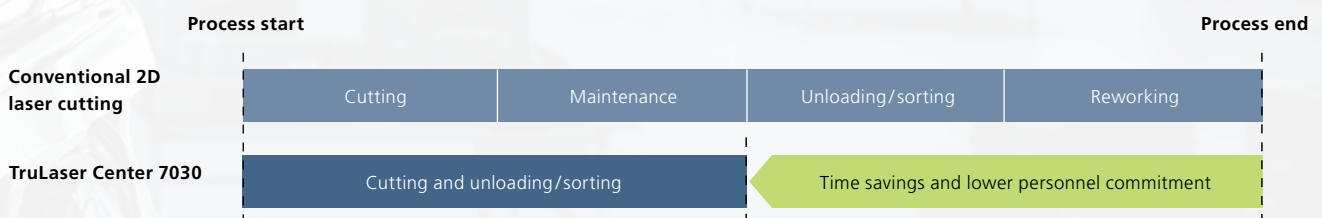

The result: the TruLaser Center 7030 takes care of all processes involving laser cutting safely and reliably – reducing your processing costs considerably.

Depending on the country, the available product range and data may differ from the details listed here. The technology, equipment, price and available accessories are subject to change. Please contact your local contact person to find out whether this product is available in your country.

Working in perfect harmony for your success

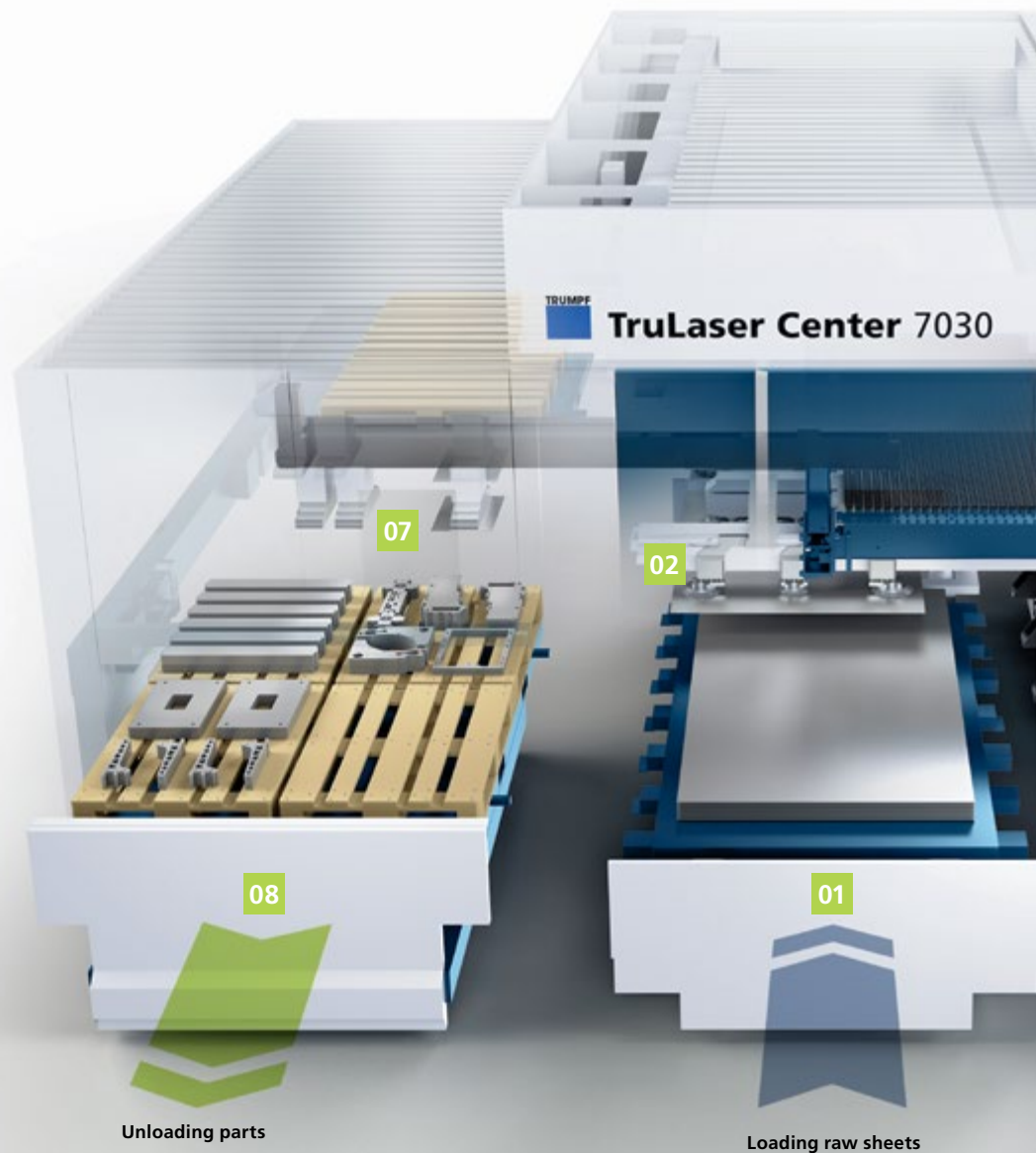

Programming an order

At the press of a button, the TruTops Boost programming system performs a fully automatic calculation for a comprehensive proposal for the cutting, removal, sorting, and depositing of your parts.

Loading raw sheets

The loading cart **(01)** can be loaded parallel to production. The LoadMaster Center **(02)** places the raw sheet on the brush table in the clamping unit. High-performance peeling techniques separate the sheet reliably from the stack.

Cutting parts

The clamping unit moves the sheet in the Y direction, the cutting unit **(03)** processes it in the X direction and also in the Y direction using a highly dynamic additional axis. The SmartGate supports the cutting process.

Anyone who wants to manufacture using laser cutting in an economical way, needs a machine in which all steps are interlinked. This is where the TruLaser Center 7030 scores with the close interaction between integrated intelligence and new automation solutions.



Unloading scrap skeletons

Removing parts and scrap

The intelligent SmartGate **(04)** removes slugs, scrap, and small parts reliably. The sorting flap separates finished cut parts from scrap. Finished parts are sorted into eight containers **(05)**. Scrap and slugs fall into a slag cart **(06)**.

Unloading parts onto stacks

The SmartLift uses its pins to push the parts out of the scrap skeleton. The finely structured suction plates of the SortMaster Speed **(07)** remove the cut parts, and sort and stack them on the parts deposit. The suction plates and pins prevent any tilting of the parts.

Unloading finished parts and scrap skeletons

The parts **(08)** are removed from the machine, sorted, and stacked parallel to production. The clamping unit unloads the scrap skeleton onto the sheet skeleton cart **(09)**. A forklift truck can empty this unrushed while the machine is operating.



See for yourself:
This is how the TruLaser Center 7030 works:
www.trumpf.info/xvnp0u



Cutting edges as smooth as glass with the CO₂ laser

The TruLaser Series 3000 is ideal if part quality and throughput time are important to you.

01

Process tubes directly

with RotoLas

02

Delicate cutting of mild steel

thanks to CoolLine

03

Utilize remainder sheets

with Drop&Cut

04

Score points in all sheet thicknesses

to a high quality standard



01

Process tubes directly

with RotoLas

Extend your parts range with tubes and profiles: You can process tubes directly on your 2D laser machine with the RotoLas option. In no time at all, you switch from flatbed to tube processing. A flexible support system guides tubes and profiles reliably and allows processing of geometries with an outer circle of up to 370 mm.



03

Utilize remainder sheets

with Drop&Cut

Save time and material: With the Drop&Cut function, you can produce single parts from remainder sheets in mere seconds. How does it work? A camera projects the image of the machine interior onto your user interface, and you can arrange part geometries on the remainder sheet as needed.



02

Delicate cutting of mild steel

thanks to CoolLine

With the CoolLine function, you can cut delicate parts and tight contours from thick mild steel. It cools your workpiece during cutting – giving you great geometrical freedom and a more efficient sheet layout.



04

Score points in all sheet thicknesses

to a high quality standard

BrightLine perfects the sectional view of your CO₂ laser: Special cutting data and the BrightLine nozzle considerably improve the quality of your cutting edges, especially with thick stainless steel. BrightLine fusion cutting creates smooth edges which are a clear-cut benefit for you – without any reworking at all.



You can find more information about TruLaser Series 3000 CO₂ laser here: www.trumpf.info/142uha



Technical data

These pages provide you with a summary of the TruLaser technical data.

Technical data			
		TruLaser 3030	TruLaser 3040
Maximum format size that can be processed			
X-axis	mm	3000	4000
Y-axis	mm	1500	2000
Z-axis	mm	116	116
Workpiece			
Max. weight (up to 6 kW)	kg	900	1700
Max. weight (8 kW and higher) ^[1]	kg	–	–
Max. speed			
Simultaneous ^[2]	m/min	140	140
Accuracy^[1]			
Positioning deviation P _a	mm	0.05	0.05
Average positioning scatter band P _{s max}	mm	0.03	0.03
Available lasers		TruFlow 3200/4000/ 5000/6000	TruFlow 3200/4000/ 5000/6000

Laser data					
		TruLaser Series 3000			
		TruFlow 3200	TruFlow 4000	TruFlow 5000	TruFlow 6000
Max. power	W	3200	4000	5000	6000
Wavelength	µm	10.6	10.6	10.6	10.6
Max. sheet thickness					
Structural steel	mm	20	20	25	25
Stainless steel	mm	12.7	15	20	25
Aluminum	mm	8	10	12.7	16
Copper	mm	–	–	–	–
Brass	mm	–	–	–	–
Power consumption					
Average power consumption during production	kW	29	31	35	38

^[1]Data relates to a single pallet. When loading several pallets, different values apply. ^[2]The positioning accuracy data relates to the entire working length. The positioning accuracy is recorded in a production plant in accordance with VDI/DGQ 3441. Subject to alteration. Only specifications in our offer and order confirmation are binding.

Intelligent functions

What intelligent functions are available to you? The table gives you a quick overview.



TruLaser Series 3000

Laser type	CO ₂
AdjustLine	■
BrightLine	■
Cutting Guide	■
Condition Guide	■
CoolLine	■
DetectLine	■
Dot Matrix Code	■
Drop&Cut	■
Dynamic Focus Control	
One-cutting-head strategy	■
Highspeed	
Highspeed Eco	
Collision protection	■
Online condition checking, protective glass	
PierceLine	■
Smart Collision Prevention	■

Extend your laser machine

From semi-automatic loading to a fully automated machine with storage connection, select the automation components that best suit your needs. Equipped with the right solution, your laser machine produces even more efficiently.



Automation functions

Loading

Loading and unloading

LoadMaster

LiftMaster Compact

LiftMaster Linear Basic



Combinable machines

TruLaser Series 3000



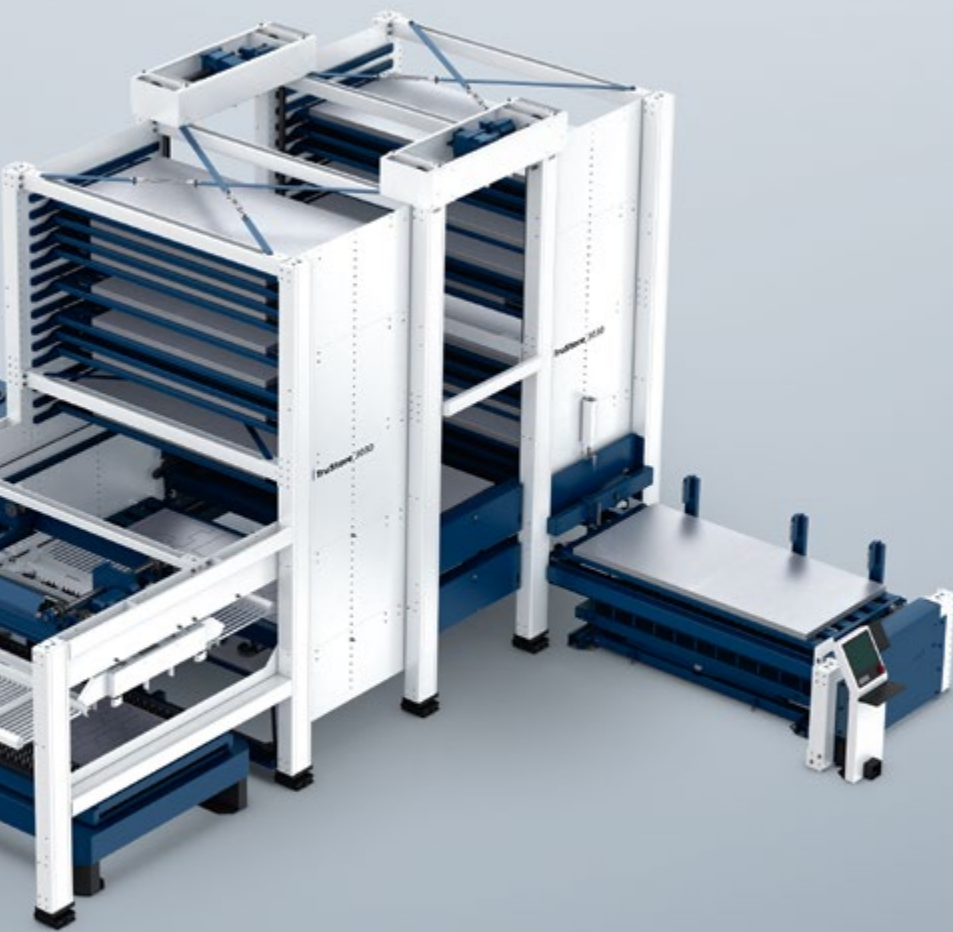

Regardless of the extent to which you wish to automate your processes: you can find the right solution for your production processes on our website and in the automation catalog: www.trumpf.info/zqi2wh

Loading and unloading/part sorting

LiftMaster



LiftMaster Linear



LiftMaster Store
LiftMaster Store Linear



SortMaster



Storage system

Material buffer



TruStore



Your Smart Factory



80%

Indirect processes make up 80% of your production time – this represents the greatest potential for savings.



Discover the potential networked production could unlock for you with these two example scenarios:
www.trumpf.com/s/smart-factory





Networked, you gain a lot of freedom: You see more, know more and get the best out of your production. Design your Smart Factory with TRUMPF – step-by-step. TRUMPF solutions accompany you on your way to networked production and are designed to help you make your entire process more transparent, more flexible, and above all – more efficient.

For companies of all sizes: from simple production solutions to an entirely interconnected facility

- **Getting started** with machines that are fundamentally equipped for networks.
- **Gradually changing** with automated machines or autonomous processing cells embedded in a production solution.
- **Networking everything** with a continuous production solution going from the incoming order to dispatch.

Smart functions and Industry 4.0

With the MobileControl app you can operate and monitor your machine easily and flexibly: It transfers the standard control panel interface to the touchscreen of your tablet. Thanks to the Central Link interface, your TruLaser machine is ready for Industry 4.0.



Lines marked with Dot Matrix Code simplify your processes.



You can monitor and control your machine in the machine environment with the MobileControl app.



You can find more information about networked production here:
www.trumpf.com/smart-factory

TruServices. Your Partner in Performance

For a successful future, choose services that will help you progress in the long term: Whether you want to create the best conditions for successful manufacturing, make the most of your TRUMPF laser systems, or have the flexibility to adapt them to changing requirements – together we will find opportunities to maximize your value creation long-term. We will provide you with all-round support as a reliable partner with solutions and service packages for your needs – enabling you to manufacture economically and at a constantly high level.

EMPOWER

If you want to create the best conditions for successful production, we will support you in this.

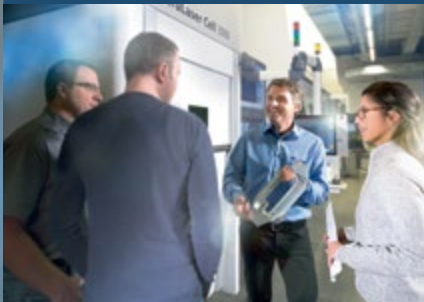

Training – reach your full potential with professional development

If you are well trained, you can fully utilize the potential of your lasers, laser systems, machines and software, and secure key competitive advantages. In the laser cutting technology course, for example, you learn how to obtain the best possible cutting quality and determine piercing parameters for special materials.

SUPPORT

If flexibility and availability of equipment in day-to-day operations are essential to you, we can help.



Service app – the app for your service messages

Whether it's a technical problem, software, a spare part or a question concerning maintenance: with the Service app and your free MyTRUMPF account, you can send your service messages quickly and easily to our Technical Service team at any time.

IMPROVE

If you want to gradually focus your production on maximum value creation, we can help you achieve your goal.



Service agreements – get just the service you need

Where system maintenance and servicing are concerned, you will benefit from expert support of the highest quality. Ensure constant maximum machine availability, consistently high production quality, and low operating costs with service agreements from TRUMPF.



 Financing	 Training	 Technical Service	 Genuine parts	 Tools	 Service agreements
 Software	 Process optimization	 Monitoring & analysis	 Product enhancements	 Pre-owned machines	



You can learn more about our complete and comprehensive package of useful services here: www.trumpf.com/s/services



Your suitable total package

From the machine to the optical system through to the technology data: At TRUMPF, we develop our products ourselves. Our sales representatives are product experts with many years of experience. Our developers have thought through every function deeply and in detail. This makes TRUMPF laser cutting machines the basis of your success.

The result



You receive a coordinated production system that is always available.

TruServices

With comprehensive services and a global service network, we are always there for you.

Software

You optimize your production processes with software solutions from TRUMPF. The TruTops Boost programming system is perfectly adapted to your TruLaser machine.

Automation

There is a large range of modular automation components available for your TruLaser machine.

Process expertise

Every machine includes up-to-date technology data for laser cutting checked by TRUMPF – this enables you to get started easily.

Optical system

We develop lasers, fiber optic laser cables, and cutting heads for each specific set of requirements and for every series. The benefit to you: you can make the best possible use of the power of your tool.

Machine

All TruLaser machines are developed and produced at TRUMPF – they provide you with a robust solution for your day-to-day industrial operations.

Passion is what drives us

Whether it's production and manufacturing technology, laser technology, or material processing – we develop highly innovative products and services for you which are tailored to your industry and which are absolutely proven and reliable. We put everything we've got into giving you a compelling, competitive edge: expertise, experience, and above all passion.



Check out our
YouTube channel:
[www.youtube.com/
@TRUMPFtube](http://www.youtube.com/@TRUMPFtube)



Machines & systems

Laser cutting, punching, bending, laser welding: With custom-fit machine tools, laser systems and automation from TRUMPF, you can master flexible sheet metal and tube processing. Not forgetting our solutions for additive manufacturing.



Lasers

Whether you are cutting, welding, marking or processing surfaces, lasers from TRUMPF are the universal tools for industrial applications – in the macro, micro and nano ranges. In addition, you will get software solutions and benefit from application knowledge and consulting.

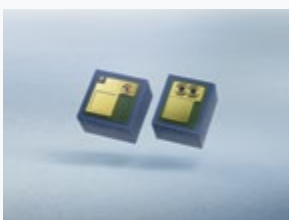

VCSEL solutions & photodiodes

Laser and photodiodes from TRUMPF Photonic Components come into their own in numerous applications: in both the industrial and consumer markets and even in optical data communication. In the TruHeat VCSEL systems, millions of VCSELs (Vertical Cavity Surface Emitting Laser) generate infrared heat, which is used for laser heat treatment.



Power electronics

Nothing's hi-tech without a process power supply: With generators for plasma technology, industrial heating, battery inverter systems or microwave amplifiers, you get power at the frequency and performance you need.



Solutions for your future

Take advantage of digital networking opportunities: we partner with you on the path to networked production, delivering pragmatic, economical solutions that make your processes both more transparent and flexible.

TRUMPF is certified to ISO 9001
(Find out more: www.trumpf.com/s/quality)

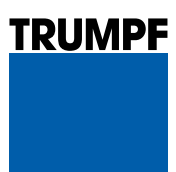

TRUMPF Werkzeugmaschinen SE + Co. KG
www.trumpf.com